

Chapter 2.3

1

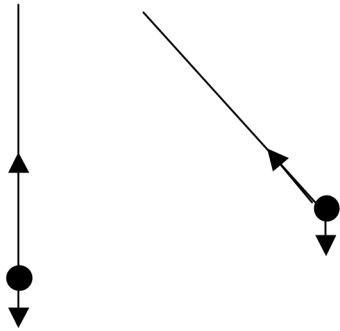

2

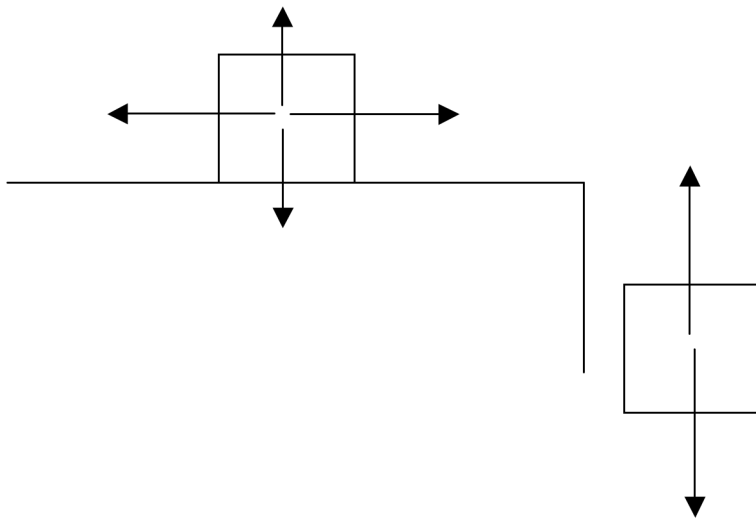

3

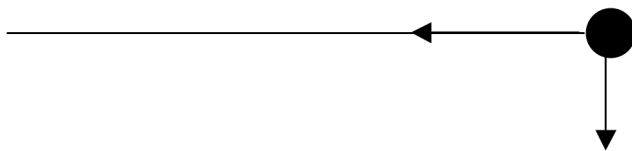

4

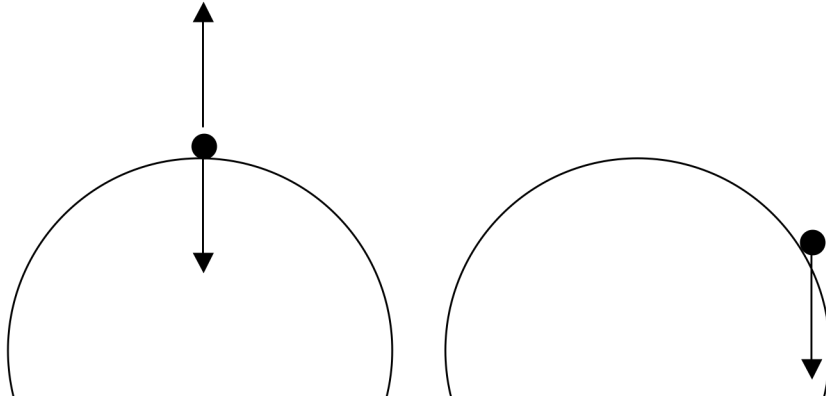

5

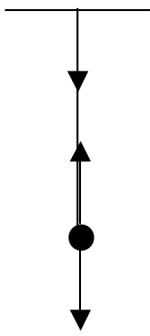

6 The tension is 50 N in both cases.

7 Assuming Hooke's law, i.e. tension proportional to extension the new tension should be $125 \times \frac{3.2}{2.8} = 143 \text{ N}$.

8

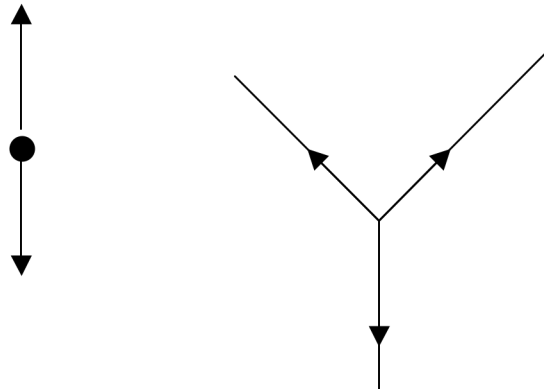

9

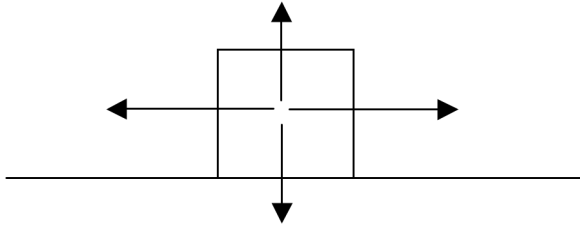

10

